



(THERMAL ENERGY STORAGE)

Generic P&ID Operation/Architecture



Suggestions For Discussions Only

CONFIDENTIAL

Proprietary Information © Smart Phases Inc. (2024)

TESS COOLING GENERIC ARCHITECTURE

- ✦ SPCM “Discharged” during on-peaks hours, avoiding startup of additional chillers
- ✦ SPCM “Charged” during off-peak hours when outside temperature is more favorable and utility rates are lower
- ✦ Chillers can be run at optimal utilization for highest efficiency
- ✦ Maximize advantage from free cooling where/when applicable

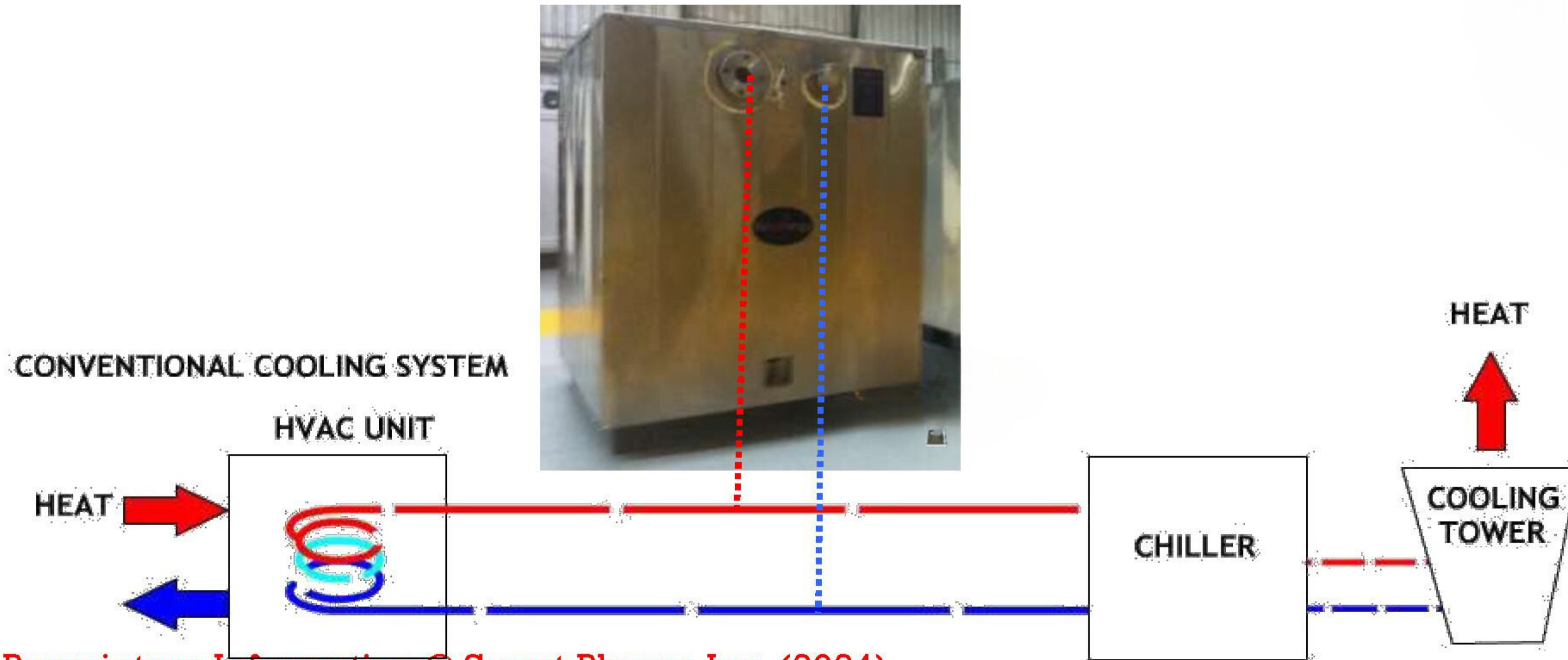

CONFIDENTIAL Proprietary Information © Smart Phases Inc. (2024)

NOVACAB TESS APPLICATIONS IN A CHILLED WATER PLANT

Architectural Overview Diagram (Generic Hybrid Parallel/Serie Approach)

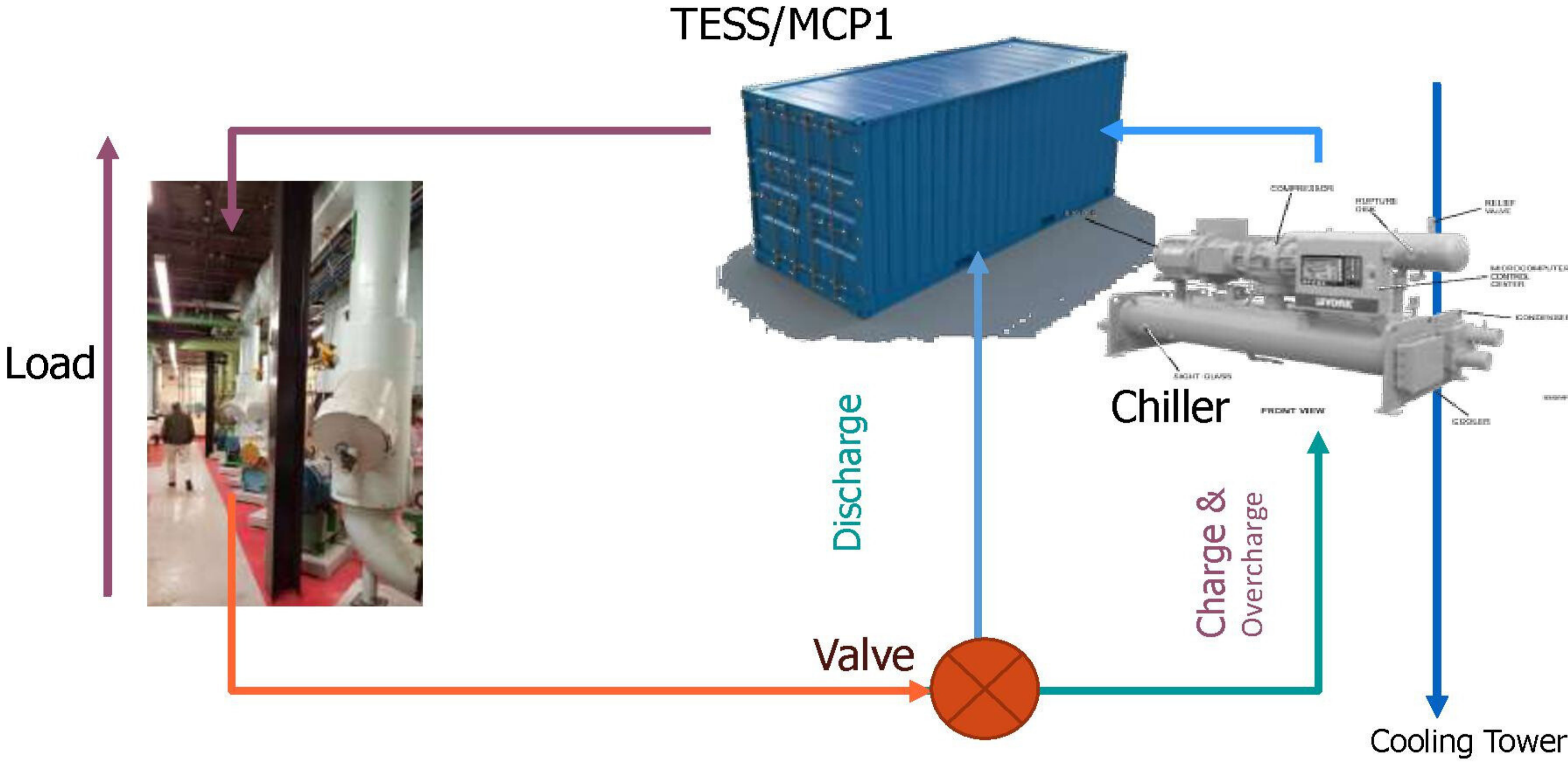

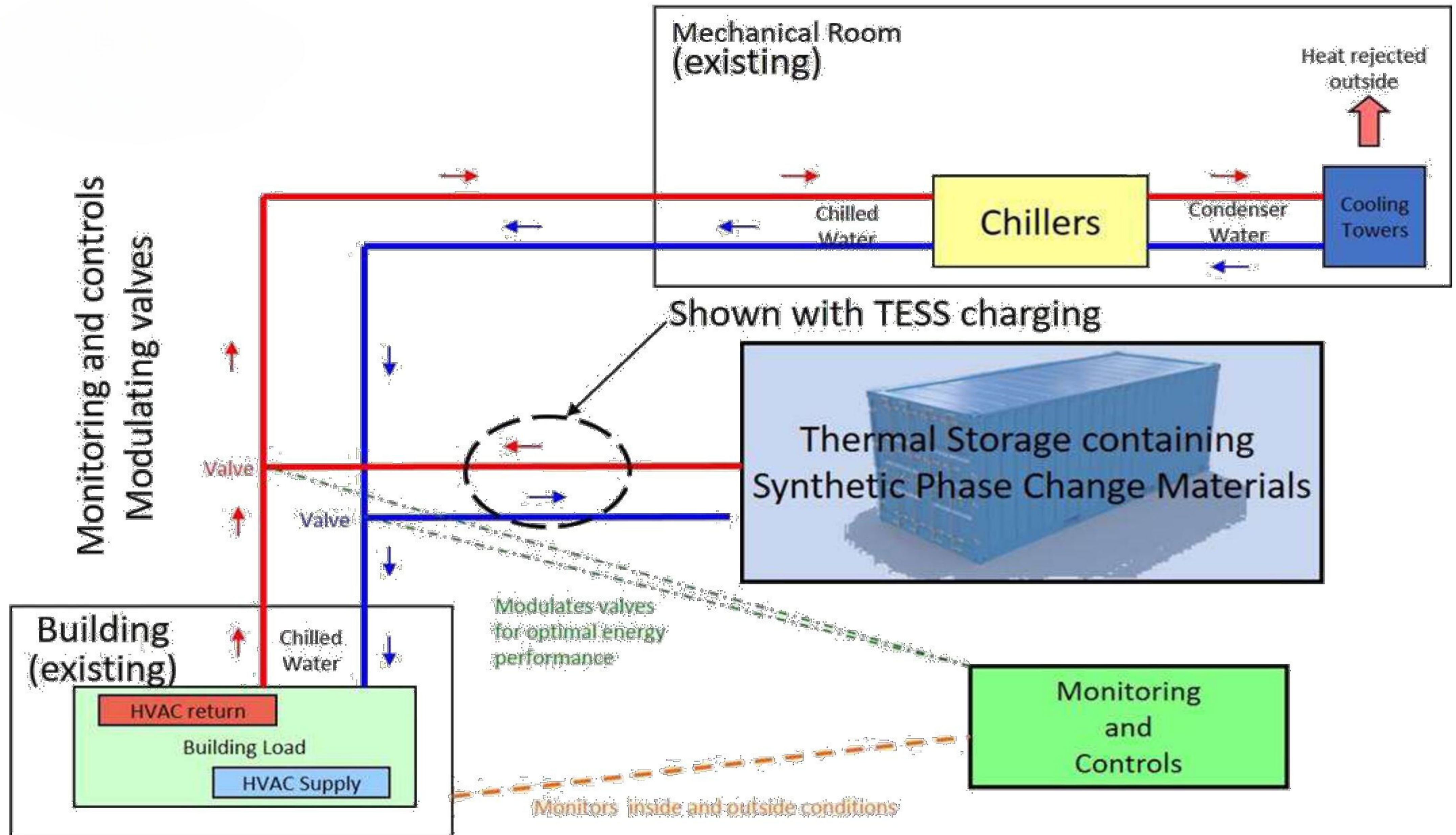

Special Architecture: Solar Panel Cooling

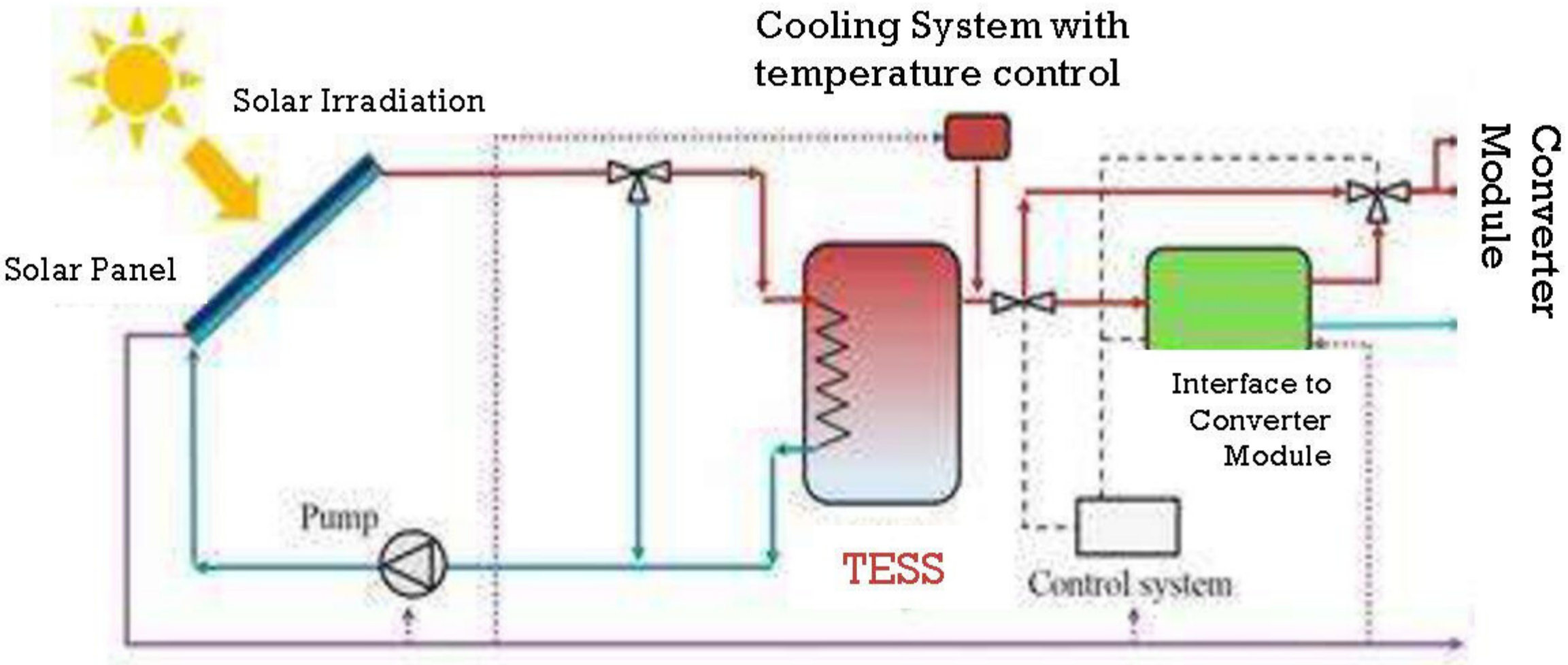

1st Set-up (option full size to mid-size system)

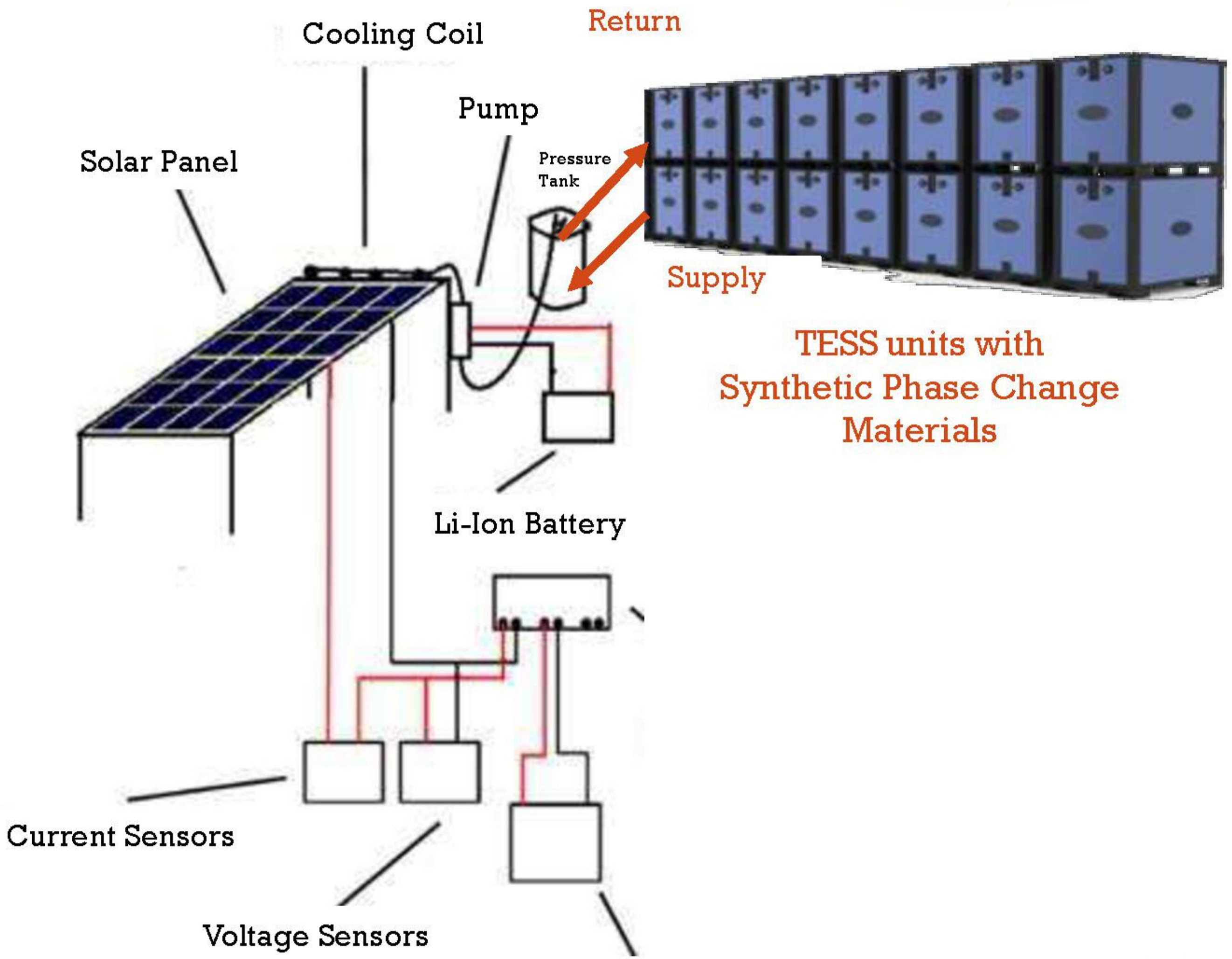

2nd Set-up (option mid-size system)

Simple Architecture: Charging/Discharging configuration for TESS in Series)

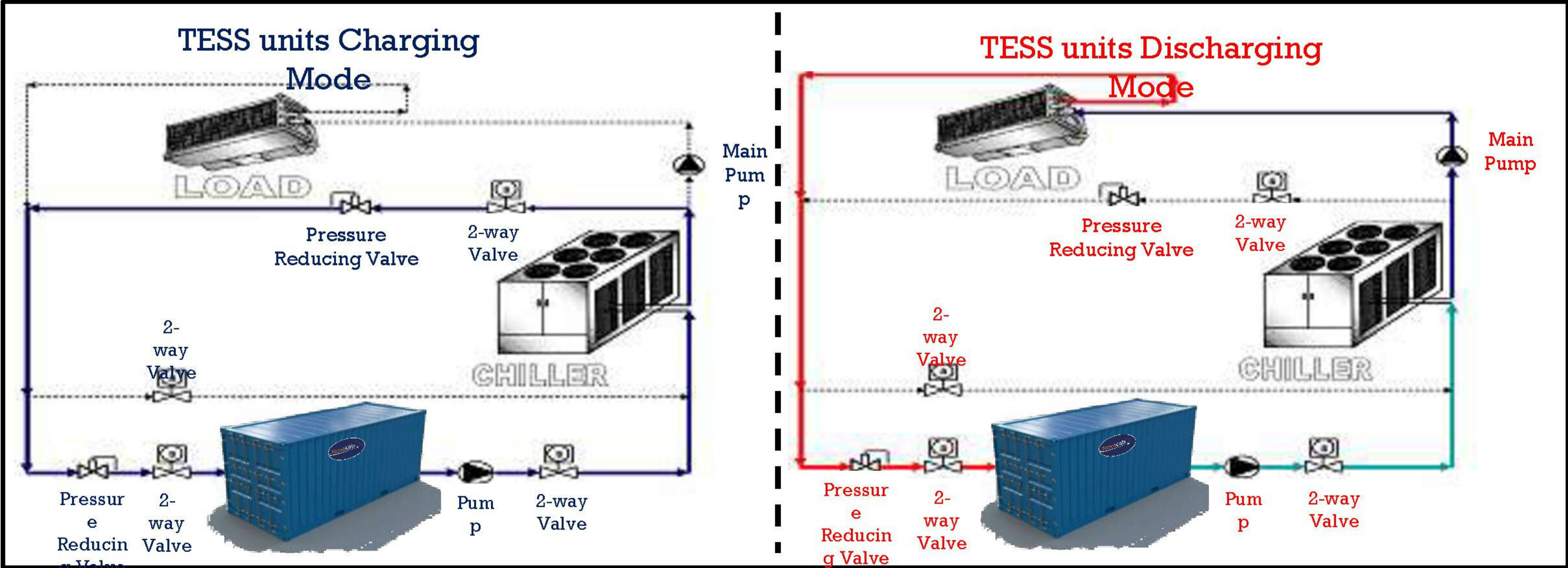

MATERIALS LIST					
No.	DESCRIPTION	DIMENSION	MATERIAL	SUPPLIER	Qty

Confidential
1

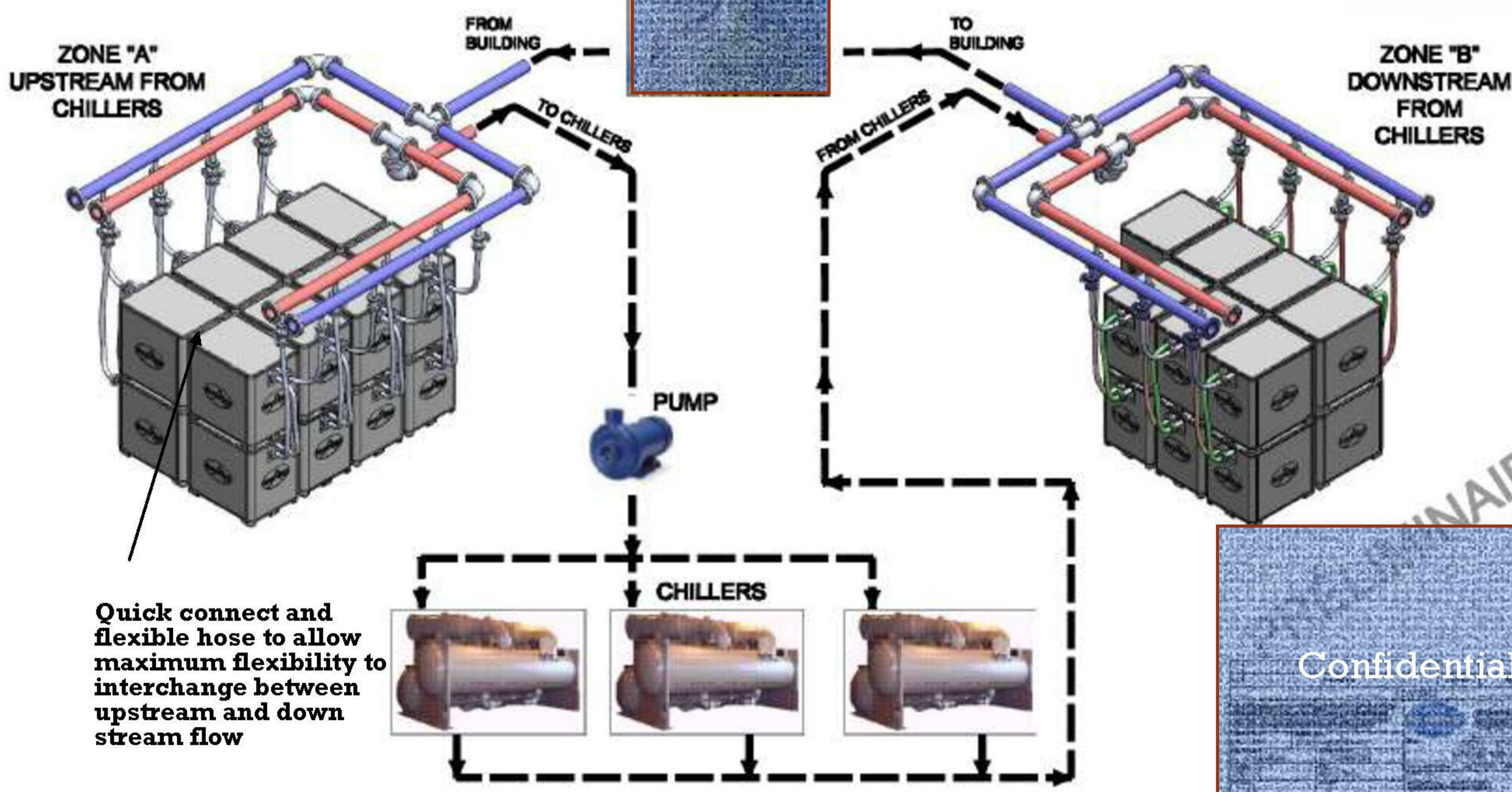

Confidential

Special Architecture: Double dT Layout (Dual Novacab TESS in Series)

TESS units with
Synthetic Phase
Change Materials

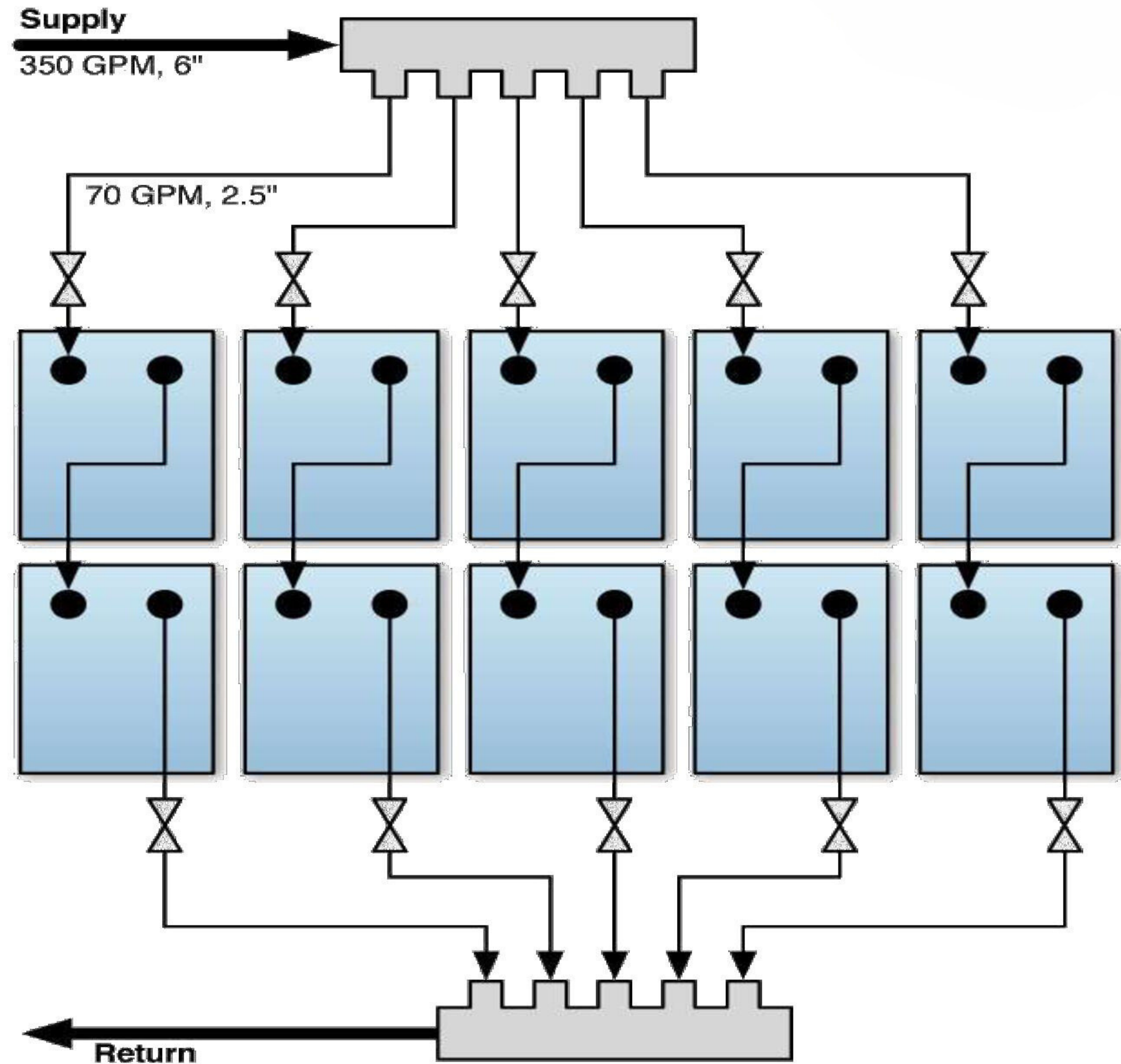
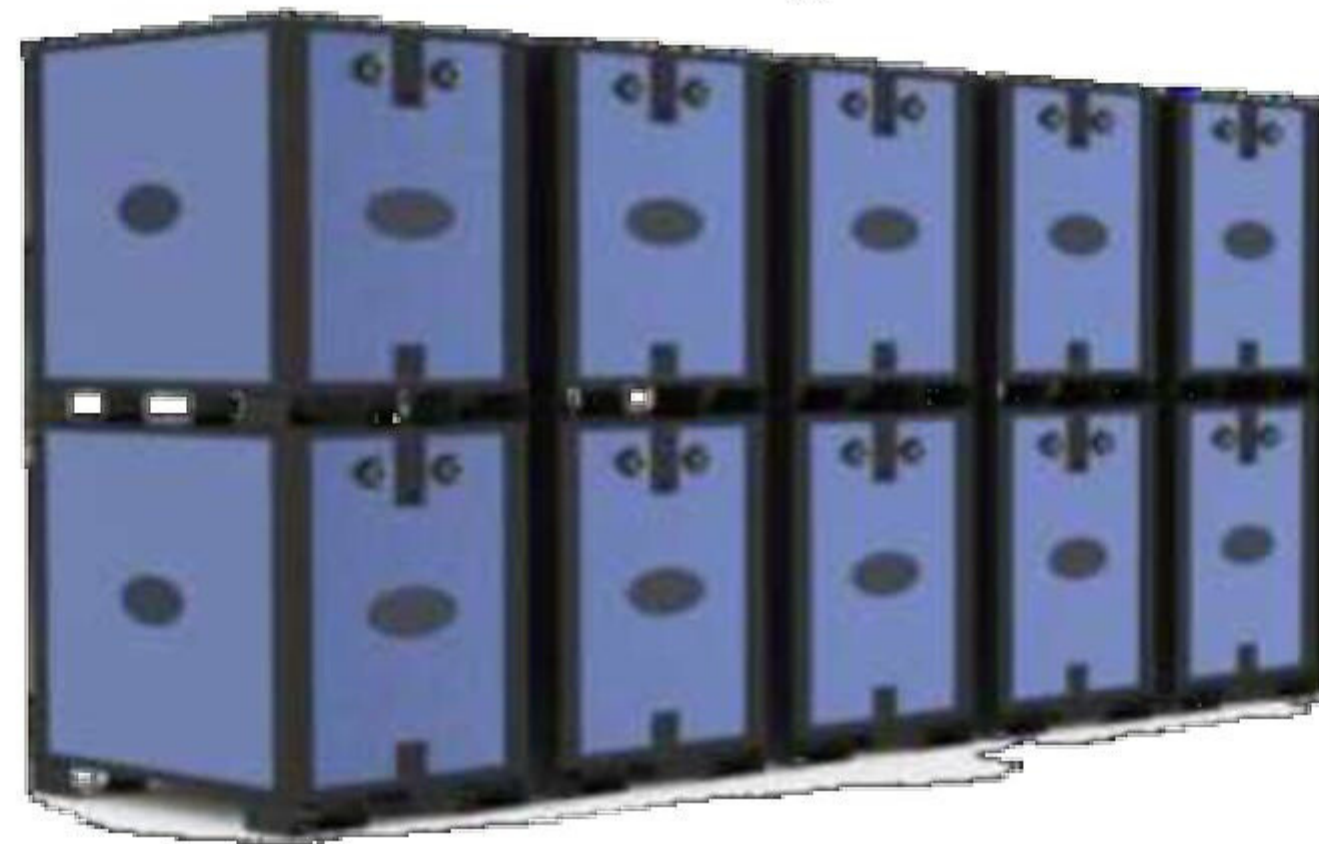

Special Architecture: Double dT Hybrid Layout (TESS In Series+Parallel)

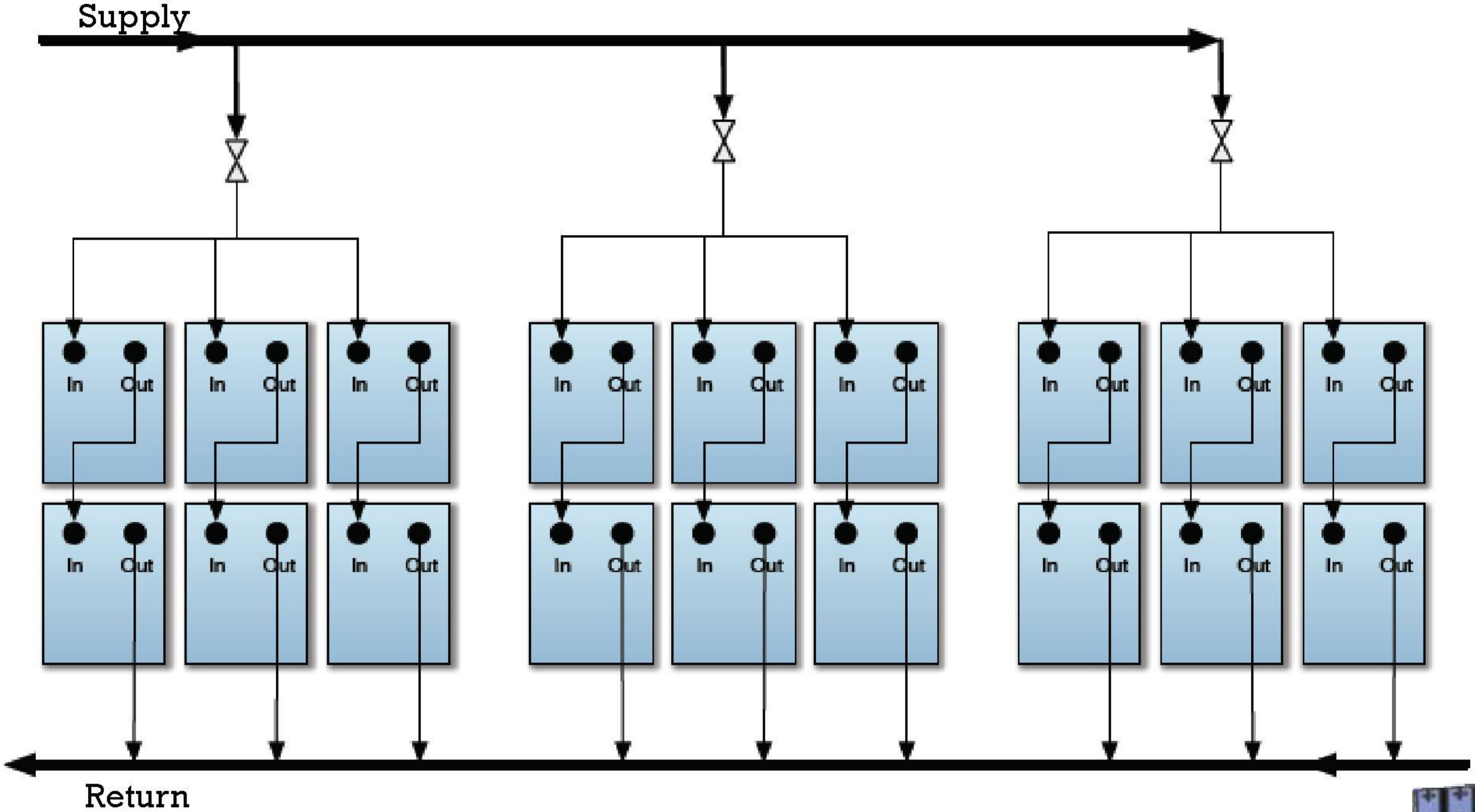

TESS units with
Synthetic Phase
Change Materials

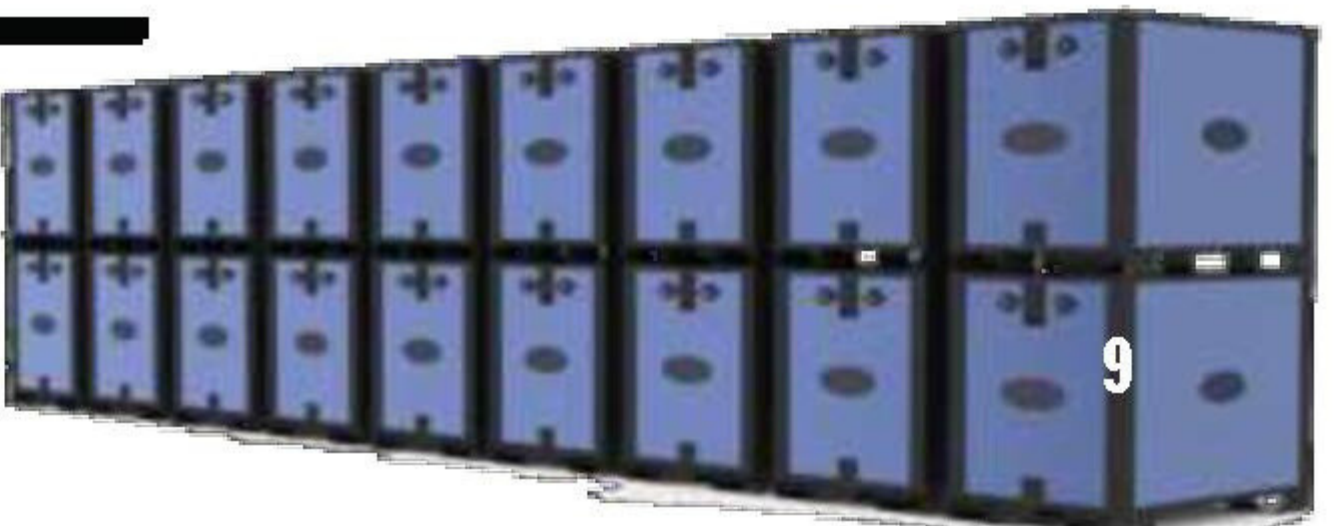

Special Architecture: Stacking configuration for TESS in Series)

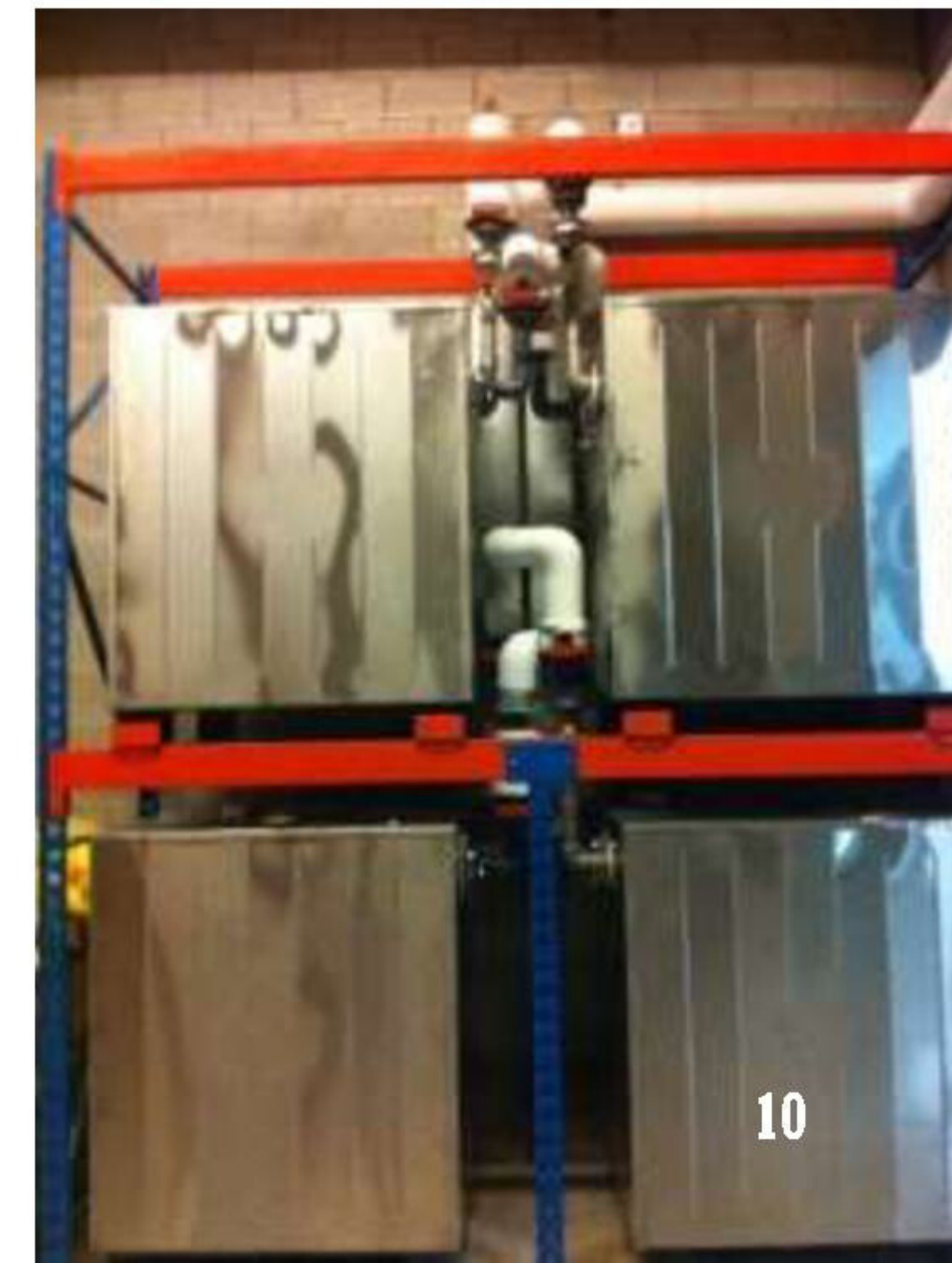
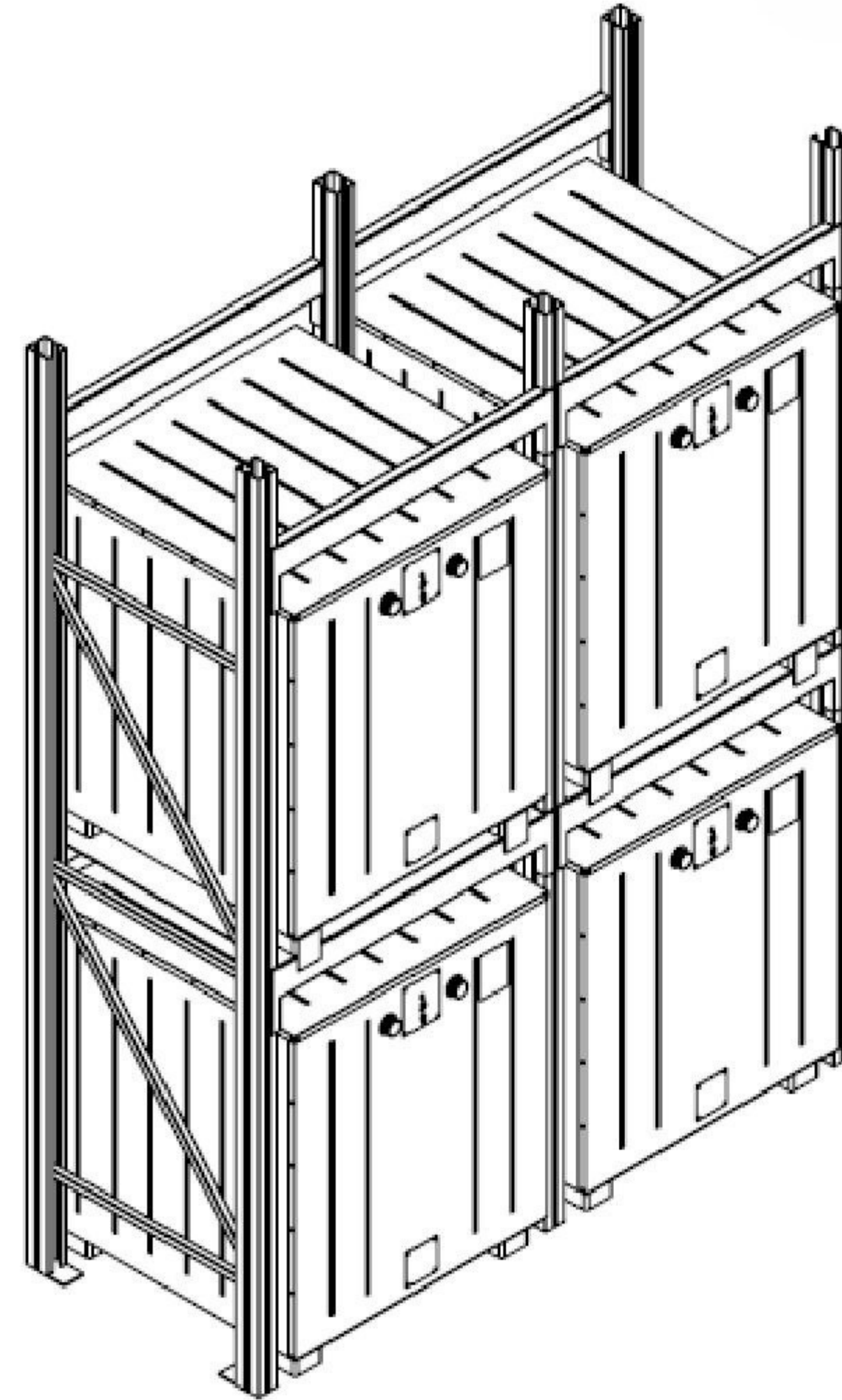
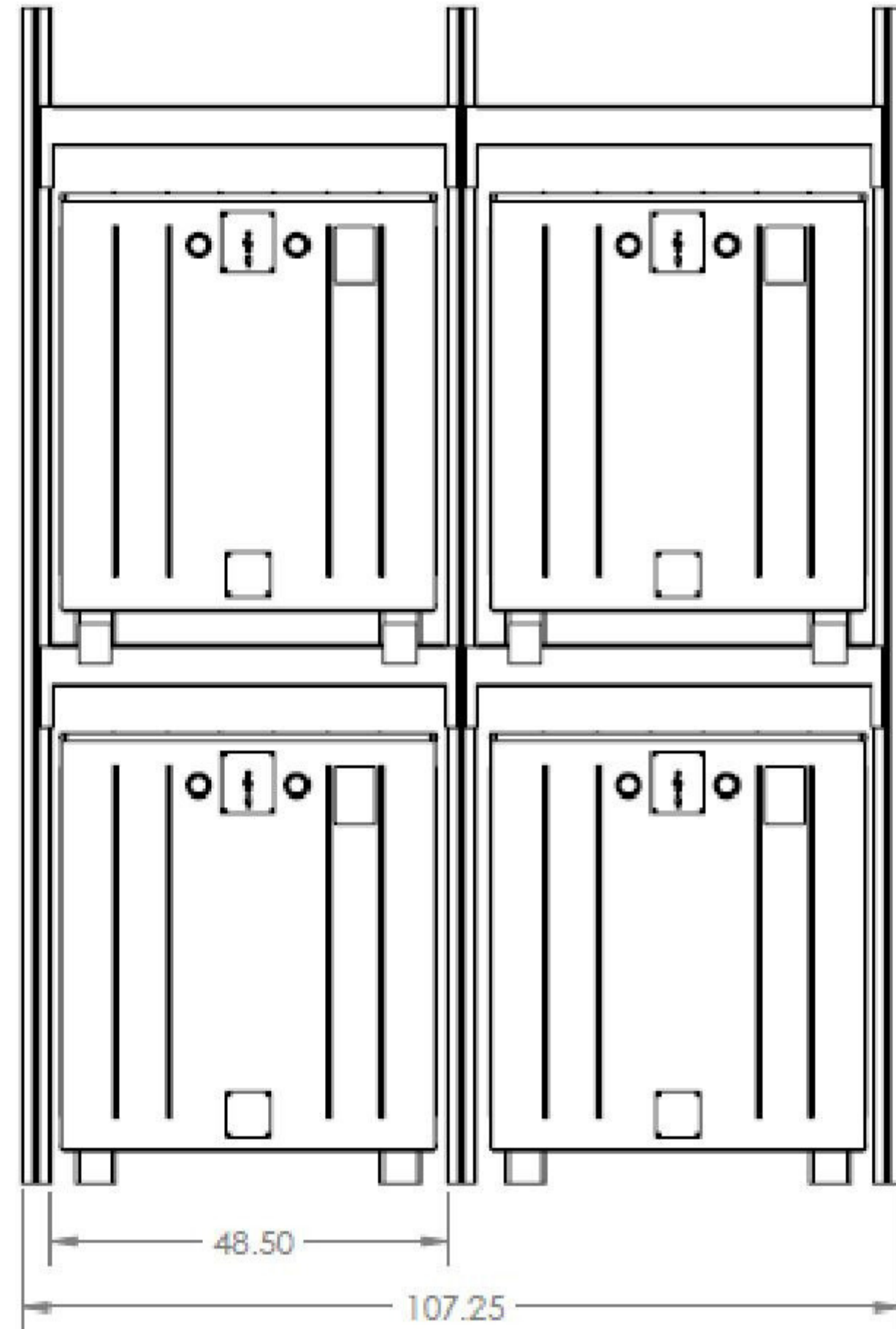
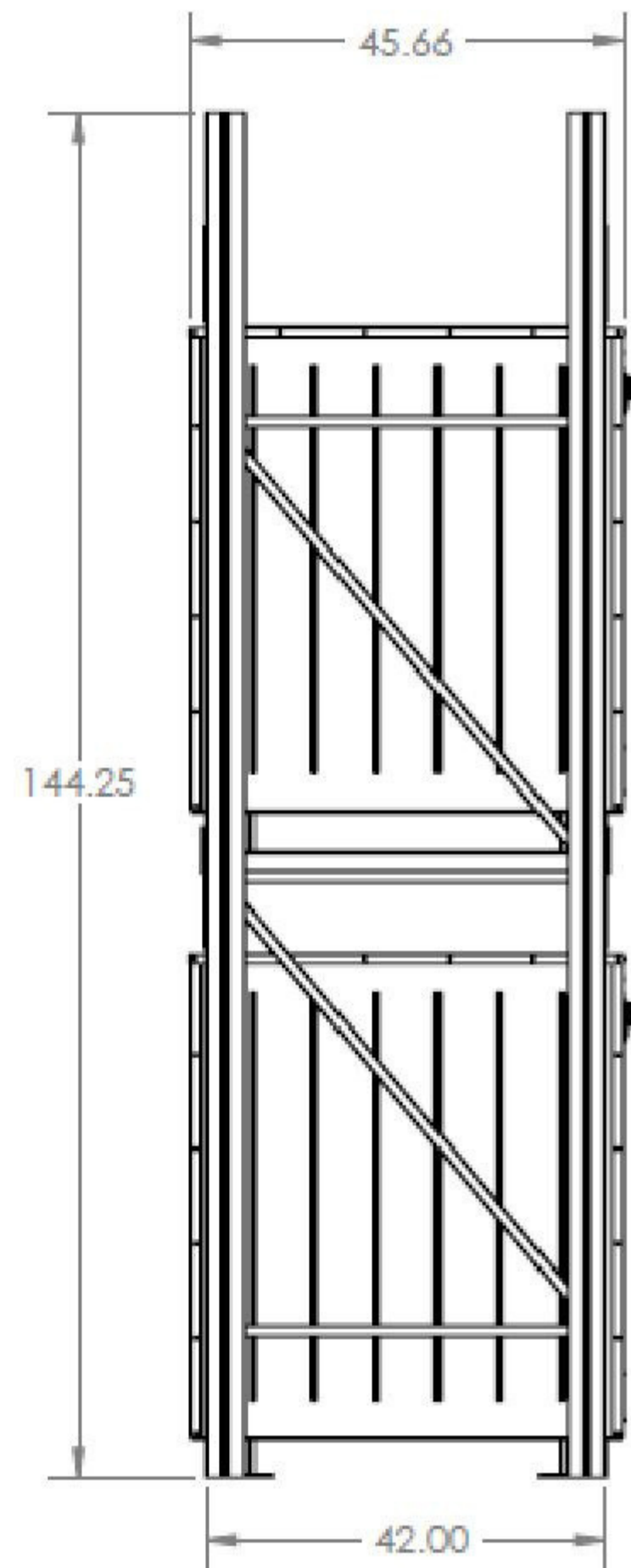

CONFIDENTIAL Proprietary Information © Smart Phases Inc. (2024)



Phoenix Green HTES
Thermal Energy Harvesting

Contact us today for more information

800-915-1009

info@thermalnrgharvesting.org